

Instructions for construction

Before product installation, read these instructions for construction carefully and retain it for future reference.

TOTO

TOTO

0G5481Y
2021.10

Contents

Contents

Contents	1
Included Parts	2
Use condition and attentions in construction	3
Attentions in construction and maintenance	4
Rough-In Illustration	5
Installation of Spout	6-8

Included Parts

Included Parts

Escutcheon	1 set
Valve Body	1 set
Wall Embedded Attachment	1 set
Screw.....	4 pc
Instructions for construction.....	1 booklet
Instructions for operation	1 booklet

Products using this specification include:
TBW08008* "G"Body Shower(Ctp)

Use condition and attentions in construction

Use condition

1. Cold water supply*hot water supply pressure:
Minimum pressure.....0.05MPa (flow pressure)
Maximum pressure.....0.75MPa (static pressure)
2. The temperature for water supply is 4~60°C. It is suggested to use the temperature below 60°C. Do not use steam to supply hot water.
3. The ambient temperature when using the product should be above 0°C and below 60°C. If the temperature is not above 0°C, deformations, cracking due to frost, etc. may occur in the handheld sprayer. Likewise, temperatures over 60°C may result in damage to the internal components of the handheld sprayer.
4. To prevent internal sprinkler damage, the water outlet temperature on the sprinkler side shall not exceed 60°C. It is suggested to use a temperature below 45°C.
5. Being out of use for a long time may result in internal and external rust to the faucet and being unable to be used.
6. If you want to scrap this product, do not treat it as you do for general household garbage. Please follow relevant statutes to have it treated, recovered and collected appropriately by an independent recovery system.
7. The product in these instructions has a cleaning function.

※ In order to achieve the best results of installation and usage, it is recommended that Body Spray be used together with other "TOTO" series products.

Attentions in construction

 Warning: it means that ignoring this mark and misoperation may cause serious personal injury and death.

 Attention: it means that ignoring this mark and misoperation may cause personal injury or property loss.

Warning

1. The hot water supply side of the water nozzle maybe in a condition of high temperature. DO not allow skin to come in contact with the hardware surface directly. Otherwise, scalding may occur.
2. Do not assemble cold * hot water tubing incorrectly; otherwise it may cause burn injuries.
3. Do not use steam to supply hot water. Otherwise, scalding may occur.
4. The water temperature will change when switch from spout to shower or switch from shower to spout. The user should test it by hand. Otherwise, scalding may occur.

Attentions in construction and maintenance

Attentions

1. Do not impact the product. Otherwise, failure, water leakage may occur.
2. It is imperative to use a neutral detergent in cleaning. Other detergents than a neutral one may damage the plating coat or make the surface discolor.
3. Do not use any such detergent as acidic detergent and abstergent, polishing powder, etc. containing thick particles and nylon brush. Otherwise, the plating coat may be damaged, etc.
4. It is allowed to use a piece of soft cloth to wipe or use from time to time a piece of cloth immersed in machine oil or vehicle wax to wipe. However, do not contact with resin components. Otherwise, they may lose the gloss and become rusty.
5. It is suggested not to leave it unused for a long time. Otherwise, this may lead to internal and external rust to water nozzle to such a degree that it cannot be used any more, etc.
6. With the product design being updated constantly, the physical object may not coincide with the figure. However, the basic principle for installation, use is the same.
7. When using in places where icing may occur, anti-freezing measures must be taken. The parts will be damaged due to icing, which may cause water leakage and property loss. Damages caused by icing are repaired for a fee even during the warranty period. Please ensure that the ambient temperature of the product is always above 0°C.

Anti-freezing measures

When using in places where icing may occur, anti-freezing measures must be taken.

1. The parts will be damaged due to icing, which may cause water leakage.
2. Damaged parts caused by icing are repaired for a fee even during the warranty period.
3. After the construction is completed or when it is not used for a long time, prepare to prevent sudden drop of temperature and prevent the product from icing.
4. Because of the risk of icing, please ensure that the ambient temperature of the product is always above 0°C.

Maintenance

To maintain a beautiful appearance of the product, the user is requested to conduct maintenance and care in the following method.

1. Wipe with a piece of soft cloth frequently and use a piece of soft cloth dipped in water to wipe from time to time.
2. When dirt exists obviously, please use water to wash sufficiently after wiping with a neutral detergent.

Rough-In Illustration

TBW08008* "G"Body Shower(Ctp)

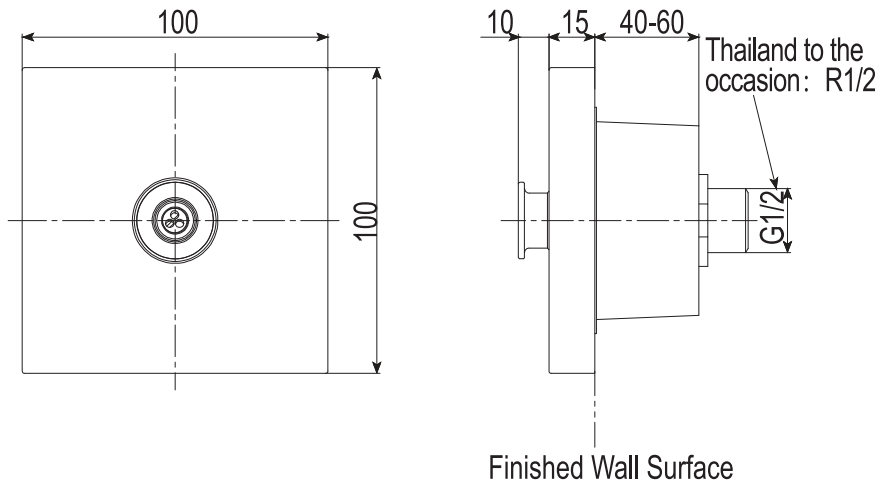

Note: The above dimensional unit is mm.
The dimensions in () are reference ones.

Installation of Spout

Tools Needed

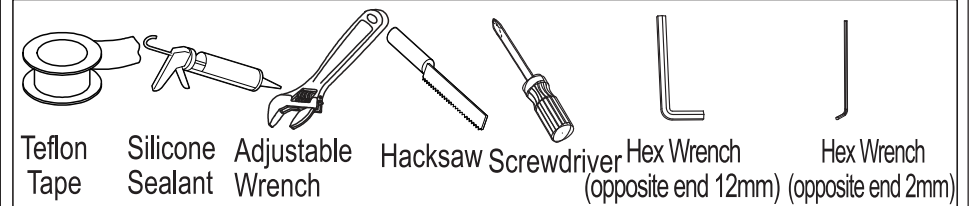

1. Piping Connection and Pressure Resistance Test
 1. It is recommended that a pre-embedded space be left for the body spray according to the dimension shown in the figure.

Attention

- The direction of the water inlet is for reference only, and the actual direction of the water inlet should be determined according to the matching mode.

2. Before installing the body spray, block the pipeline elbow with a pipeline water pressure test plug. (water pressure test plug sold separately)
3. Before installation, be sure to flush out the dust, gravel and other foreign objects in the water supply pipeline; during the installation, also make sure not to let the impurities such as sediment enter the body spray or the inside of the water supply pipeline.

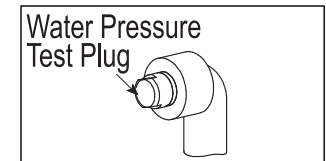
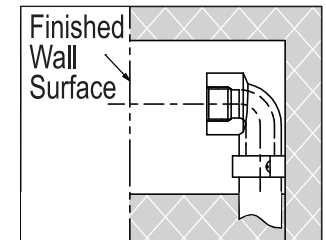
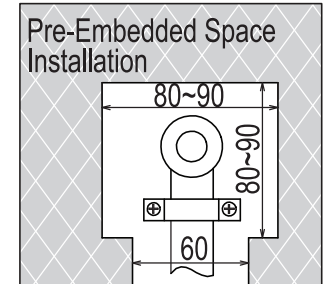

Installation of Spout

II. Installation of the Wall Embedded Attachment

1. Shut off the water valve, remove the water pressure test plug used for pressure resistance test, and wrap the installation thread on the wall embedded main attachment with teflon tape. Insert a hex wrench (12mm) into the hole in the body and turn to tighten.

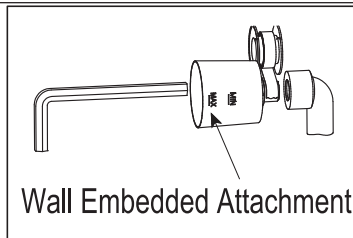

Wall Embedded Attachment

Attention

- Note that the positions of the four screw holes of the fixed (fastened) joint should be arranged in a positive "+" form.
- Make sure thread engagement is more than 4 turns.
- Make sure to check whether there is water leakage after the fixed (fastened) joint is screwed in.
- Check whether the finished wall is within the installation adjustment range on the outer plaster guard.

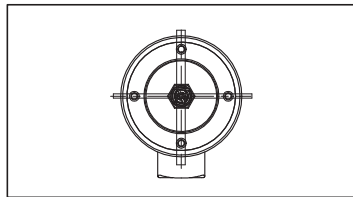

Finished Wall Surface

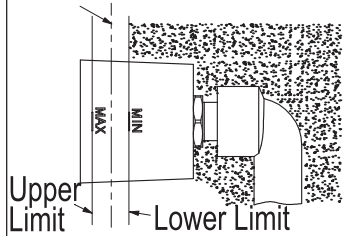

Wall Hole Diameter

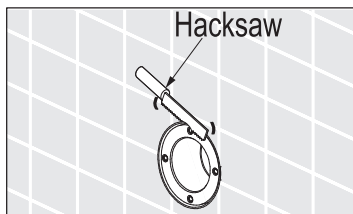
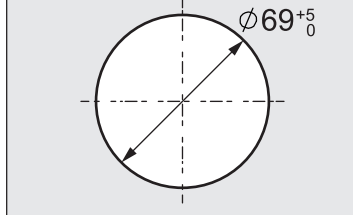

Hacksaw

III. Completion of the Wall Installation

1. Backfill the Wall with Cement Mortar.

Attention

- When backfilling the wall, make sure the cement mortar does not go beyond into the inner side of the fastened joint.
- If the opening of the finished wall installation exceeds the specified dimension, the mobile part will not be installed as intended. Hence, please set the opening of the finished wall installation within the range of $\phi 69^{+5}$.
- Make sure the finished wall is within the installation parameters.

IV. Installation of the Body Spray

1. Cut off part of the outer plaster guard that protrudes from the wall surface with a sabre hacksaw, and make sure the edge of the outer plaster guard is aligned with the finished wall surface after the cutting.

Attention

- When cutting the protective shell of the fastened joint, make sure the edge is cut off neatly. (The edge should not be sunken inside the finished wall surface)

Installation of Spout

2. Apply the silicone sealant evenly in the gap between the outer plaster guard and the finished wall, the sealant surface should not extend from the finished wall surface.
3. First clean the inside of the wall embedded attachment, use a hex wrench (2mm) to remove the escutcheon from the valve body, and then insert the valve body into the inside of the fastened joint (apply soap water to the O-ring for easy installation). Align the screw mounting holes of the lining plate of the valve body with the threaded holes of the fastened joint, insert the screws, tighten the screws with a screwdriver until the lining plate is pressed to the finished wall surface.

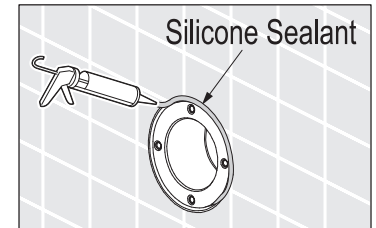

Silicone Sealant

Make sure the notch on the lining plate faces up

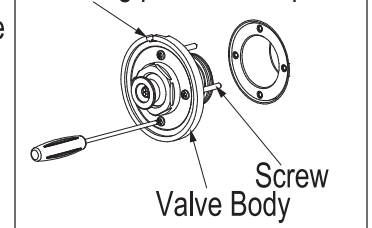

Screw
Valve Body

Attention

- Check whether the O-ring has any damage or dirt before inserting the valve body.

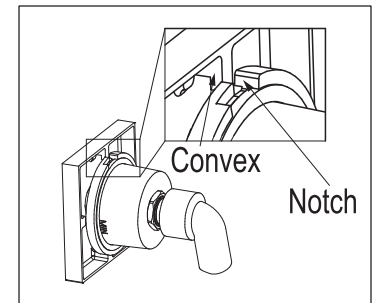

Convex
Notch

4. Insert the escutcheon by aligning its extended part with the notch on the lining plate, and rotate the escutcheon clockwise. When adjusting the position of the escutcheon, tighten the small screws under the escutcheon with a hex wrench to attach the escutcheon.

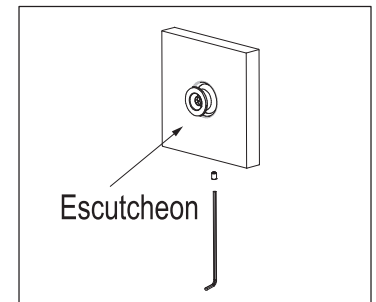

Escutcheon

TOTO Asia Oceania Pte. Ltd.

Telephone:65-6744-6955

FAX: 65-6841-0819

Address: 10 Eunos Road 8 #12-07 Singapore Post Centre
Singapore 408600

Website:asia.toto.com

TOTO KOREA LTD.

전화번호 : (02)-3141-8236

FAX 번호 : (02)-3141-8240

주소 : 서울시 마포구 토정로 112(상수동, 로이코빌딩 3층)

홈페이지 : <https://kr.toto.com>